

## Pneumatically operated 2/2-way angle seat valve with stainless steel actuator

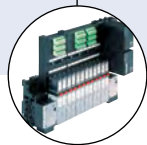

- Flow optimised stainless steel body with various line connections
- Trusted components for the longest life time
- Stainless steel actuator suitable for demanding environments
- Modular accessory program with stroke limitation and position feedback available

Type 2060 can be combined with...



**Type 8640**  
Valve island



**Type 8644**  
Valve island



**Type 8697**  
Feedback

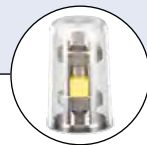

**Stroke limiter**



The pneumatically operated angle seat valve with stainless steel actuators fulfils the demands of tough process environments. Unrivalled life time and sealing integrity is guaranteed by the trusted self-adjusting spindle sealing. The stainless steel actuator has been designed for tough applications. Laser welding ensures it is both cleanable and robust. With a ducted exhaust air port, the actuator can be operated isolated from the environment to guarantee an optimum life time and hygiene. High flow rates are attained with the optimised stainless steel angle seat body. As part of the Bürkert process valve range a large accessory program is available. All wetted parts comply with the EC Directive 1935/2004, variants with FDA conformity are available on request, also explosion proof variants are available.

Technical data	
<b>Orifice</b>	DN15 to DN65; ½" to 2½"
<b>Port connections</b> Welded acc. to	DIN EN ISO 1127/ISO 4200/DIN 11866 series B DIN 11850 series 2/DIN 11866 series A/DIN EN 10357 series A ASME BPE / DIN 11866 series C on request: SMS 3008 and BS485
Clamp and threaded	on request
<b>Body material</b>	Stainless steel 316L
<b>Nominal pressure</b>	PN25 (Body)
<b>Actuator material</b>	1.4404 (316L), 1.4308
<b>Sealing material</b>	PTFE (others on request)
<b>Medium</b>	Water, alcohol, oils, fuels, hydraulic fluids, salt solution, alkali solutions, organic solvents, steam
<b>Viscosity</b>	max. 600 mm <sup>2</sup> /s
<b>Spindle packing</b>	PTFE V-rings with spring compensation
<b>Medium temperature</b>	- 10 °C to 185 °C
<b>Ambient temperature</b>	0 °C to 100 °C at 150 °C medium temperature 0 °C to 80 °C at 150 °C < medium temperature ≤ 185 °C
<b>Control medium</b>	Neutral gases, air
<b>Max. pilot pressure</b>	10,5 bar 7,5 bar for actuator size 130 mm (P)
<b>Pilot air ports</b>	thread G ½
<b>Installation</b>	As required, preferably with actuator in upright position
<b>Surface Finish</b>	Int. Ra ≤ 3.2 µm (others on request)

### Content



Valve specifications  
Type 2060

Technical data & ordering info

p. 1 - 4



System spec. On/Off ELEMENT  
Type 8801-YE

Technical data & ordering info

p. 9

Request for quotation  
Type 8801-YE

p. 11

Technical data angle seat valve Type 2060 flow direction below the seat (for gases and liquids)

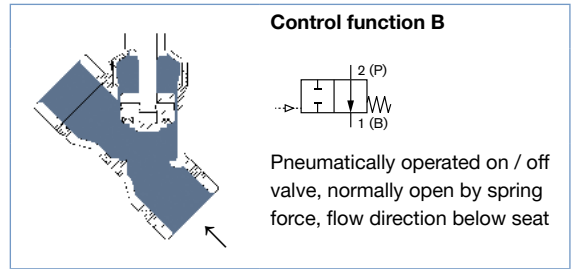
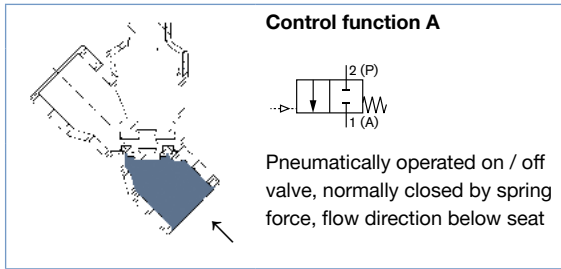

Orifice [mm]	Orifice [inch]	Actuator size [mm]	K <sub>v</sub> value water [m <sup>3</sup> /h]	Minimum pilot pressure CFA [bar]	Operating pressure up to +185 °C	
					CFA [bar]	CFB [bar]
15	1/2"	50 (D)	4.2	3.9	16	16
20	3/4"	50 (D)	8	3.9	11	16
		70 (M)	11	16	16	
25	1"	50 (D)	14	3.9	5.2	16
		70 (M)	18	5.0	16	16
32	1 1/4"	70 (M)	27	5.0	8.5	16
		90 (N)	28	5.0	16	16
		90 (N)	40	5.0	16	16
40	1 1/2"	70 (M)	38	5.0	6	16
		90 (N)	40	5.0	16	16
50	2"	90 (N)	55	5.0	10	16
		130 (P)	62	5.0	16	16
65	2 1/2"	90 (N)	85	5.0	5	12
		130 (P)	95	5.6	12	12

Flow rate: K<sub>v</sub> value water [m<sup>3</sup>/h]: Measured at +20 °C, 1 bar pressure at valve inlet and free outlet.





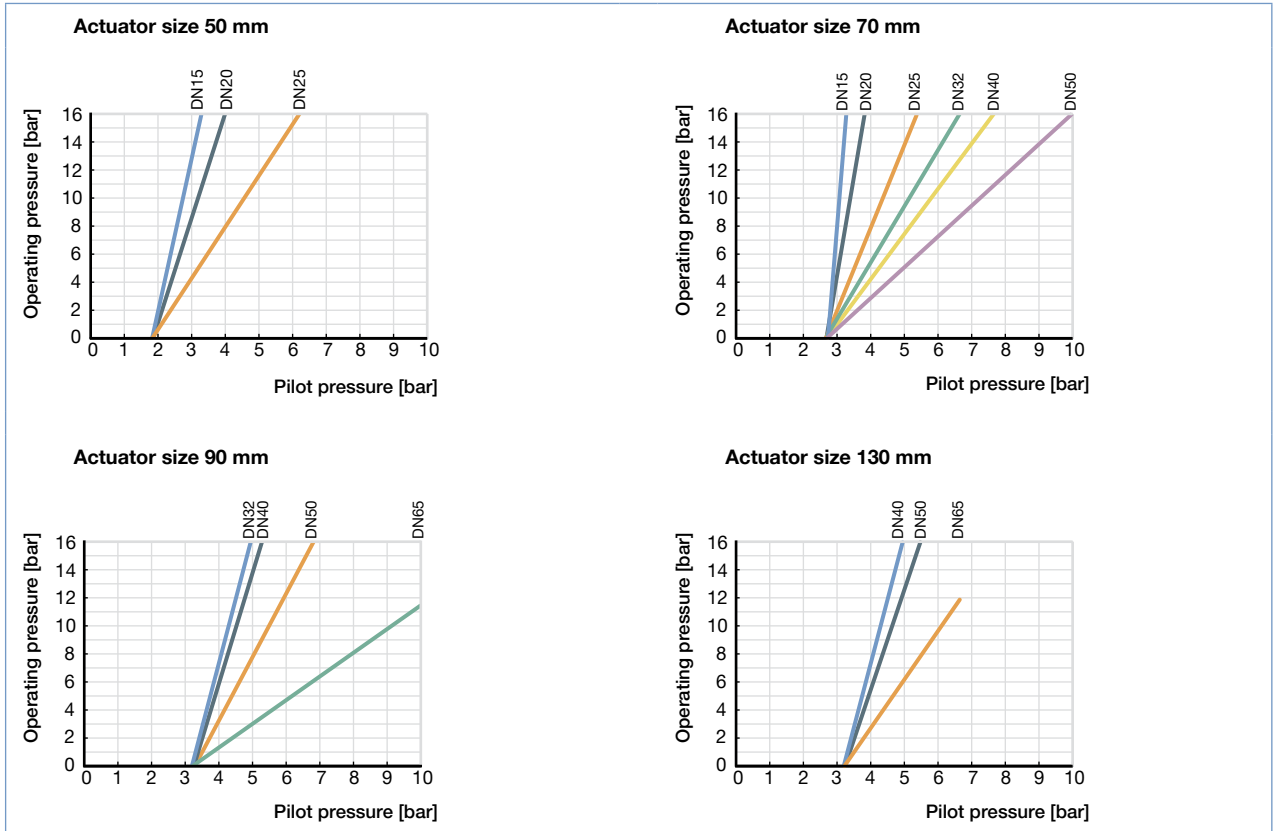





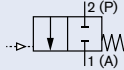













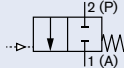













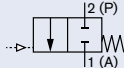

Pressure valves [bar]: Overpressure to the atmospheric pressure

Pressure charts with control function B and flow direction below the seat



## Ordering chart angle seat valve Type 2060, flow direction below the seat (for gases and liquids)











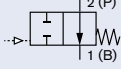









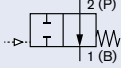





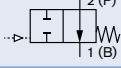

## Weld end body, flow direction below the seat, others on request

Control function	Orifice		Port connection tube Ø x wall thick- ness [mm]	Actuator size [mm]	Pilot pressure [bar]	Operating pressure up to +185 °C [bar]	Article no.
	[mm]	[inch]					
<b>Acc. EN ISO 1127/ISO 4200/DIN 11866 series B</b>							
A Pneumatically oper- ated on / off valve, normally closed by spring force, flow di- rection below seat  	15	½"	21.3 × 1.6	50 (D)	3.9 ... 10.5	16	285215 
	20	¾"	26.9 × 1.6	50 (D)	3.9 ... 10.5	11	285217 
				70 (M)	5.0 ... 10.5	16	285218 
	25	1"	33.7 × 2.0	50 (D)	3.9 ... 10.5	5.2	285219 
				70 (M)	5.0 ... 10.5	16	285220 
	32	1¼"	42.4 × 2.0	70 (M)	5.0 ... 10.5	8.5	285221 
				90 (N)	5.0 ... 10.5	16	285222 
	40	1½"	48.3 × 2.0	70 (M)	5.0 ... 10.5	6	285223 
				90 (N)	5.0 ... 10.5	16	285224 
	50	2"	60.3 × 2.0	90 (N)	5.0 ... 10.5	10	285515 
				130 (P)	5.0 ... 7.5	16	285705 
				90 (N)	5.0 ... 10.5	5	285227 
	65	2½"	76.1 × 2.3	90 (N)	5.0 ... 10.5	5	285227 
				130 (P)	5.6 ... 7.5	12	285228 
<b>Acc. DIN 11850 series 2/DIN 11866 series A/DIN EN 10357 series A</b>							
A Pneumatically oper- ated on / off valve, normally closed by spring force, flow di- rection below seat  	15	½"	19.0 × 1.5	50 (D)	3.9 ... 10.5	16	285201 
	20	¾"	23.0 × 1.5	50 (D)	3.9 ... 10.5	11	285203 
				70 (M)	5.0 ... 10.5	16	285204 
	25	1"	29.0 × 1.5	50 (D)	3.9 ... 10.5	5.2	285205 
				70 (M)	5.0 ... 10.5	16	285206 
	32	1¼"	35.0 × 1.5	70 (M)	5.0 ... 10.5	8.5	285207 
				90 (N)	5.0 ... 10.5	16	285208 
	40	1½"	41.0 × 1.5	70 (M)	5.0 ... 10.5	6	285209 
				90 (N)	5.0 ... 10.5	16	285210 
	50	2"	53.0 × 1.5	90 (N)	5.0 ... 10.5	10	285211 
				130 (P)	5.0 ... 7.5	16	285212 
				90 (N)	5.0 ... 10.5	5	285213 
	65	2½"	70.0 × 2.0	90 (N)	5.0 ... 10.5	5	285213 
				130 (P)	5.6 ... 7.5	12	285214 
<b>Acc. ASME BPE/DIN 11866 series C</b>							
A Pneumatically oper- ated on / off valve, normally closed by spring force, flow di- rection below seat  	15	½"	12.7 × 1.65	50 (D)	3.9 ... 10.5	16	285189 
	20	¾"	19.05 × 1.65	50 (D)	3.9 ... 10.5	11	285191 
				70 (M)	5.0 ... 10.5	16	285192 
	25	1"	25.4 × 1.65	50 (D)	3.9 ... 10.5	5.2	285193 
				70 (M)	5.0 ... 10.5	16	285194 
	40	1½"	38.1 × 1.65	70 (M)	5.0 ... 10.5	6	285195 
				90 (N)	5.0 ... 10.5	16	285196 
	50	2"	50.8 × 1.65	90 (N)	5.0 ... 10.5	10	285197 
				130 (P)	5.0 ... 7.5	16	285198 
				90 (N)	5.0 ... 10.5	5	285199 
	65	2½"	63.5 × 1.65	90 (N)	5.0 ... 10.5	5	285199 
				130 (P)	5.6 ... 7.5	12	285200 

**i Further versions on request****Control function**  
I (double-acting)**Port connection**  
(threaded port / clamp)

## Ordering chart angle seat valve Type 2060, flow direction below the seat (for gases and liquids)

## Weld end body, flow direction below the seat, others on request

Control function	Orifice		Port connection tube Ø x wall thickness [mm]	Actuator size [mm]	Pilot pressure [bar]	Operating pressure up to +185 °C [bar]	Article no.
	[mm]	[inch]					
<b>Acc. EN ISO 1127/ISO 4200/DIN 11866 series B</b>							
B Pneumatically operated on / off valve, normally open by spring force, flow direction below seat 	15	½"	21.3 × 1.6	50 (D)	see pressure chart	16	285500 
				70 (M)		16	287565 
	20	¾"	26.9 × 1.6	50 (D)		16	285501 
				70 (M)		16	287566 
	25	1"	33.7 × 2.0	70 (M)		16	285503 
	32	1¼"	42.4 × 2.0	70 (M)		16	285504 
	40	1½"	48.3 × 2.0	70 (M)		16	285505 
50	2"	60.3 × 2.0	70 (M)	16	287567 		
65	2½"	76.1 × 2.3	90 (N)	12	285511 		
<b>Acc. DIN 11850 series 2/DIN 11866 series A/DIN EN 10357 series A</b>							
B Pneumatically operated on / off valve, normally open by spring force, flow direction below seat 	15	½"	19.0 × 1.5	50 (D)	see pressure chart	16	287555 
				70 (M)		16	287556 
	20	¾"	23.0 × 1.5	50 (D)		16	287557 
				70 (M)		16	287558 
	25	1"	29.0 × 1.5	70 (M)		16	287559 
	32	1¼"	35.0 × 1.5	70 (M)		16	287560 
	40	1½"	41.0 × 1.5	70 (M)		16	287561 
50	2"	53.0 × 1.5	90 (N)	16	287562 		
65	2½"	70.0 × 2.0	90 (N)	12	287563 		
<b>Acc. ASME BPE/DIN 11866 series C</b>							
B Pneumatically operated on / off valve, normally open by spring force, flow direction below seat 	15	½"	12.7 × 1.65	50 (D)	see pressure chart	16	285499 
				70 (M)		16	287548 
	20	¾"	19.05 × 1.65	50 (D)		16	287549 
				70 (M)		16	287550 
	25	1"	25.4 × 1.65	70 (M)		16	287551 
	40	1½"	38.1 × 1.65	70 (M)		16	287552 
	50	2"	50.8 × 1.65	70 (M)		16	285509 
65	2½"	63.5 × 1.65	90 (N)	12	287553 		

Technical data angle seat valve Type 2060 flow direction above the seat (for gases and liquids)

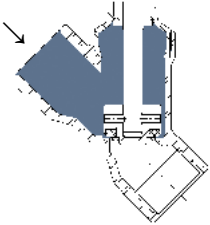

**Control function A**

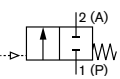

Pneumatically operated on / off valve, normally closed by spring force, flow direction above seat

**Attention!**

Valves with flow above the seat are only conditionally usable for liquid medium. There is a danger of waterhammer!

Orifice		Actuator size [mm]	K <sub>v</sub> value water [m <sup>3</sup> /h]	Operating pressure up to +185 °C CFA [bar]
[mm]	[inch]			
15	½"	50 (D)	4.2	16
20	¾"	50 (D)	8	16
25	1"	50 (D)	14	16
32	1¼"	70 (M)	28	16
40	1½"	70 (M)	38	16
50	2"	70 (M)	50	12
		90 (N)	55	15

Flow rate: K<sub>v</sub> value water [m<sup>3</sup>/h]: Measured at +20 °C, 1 bar pressure at valve inlet and free outlet.





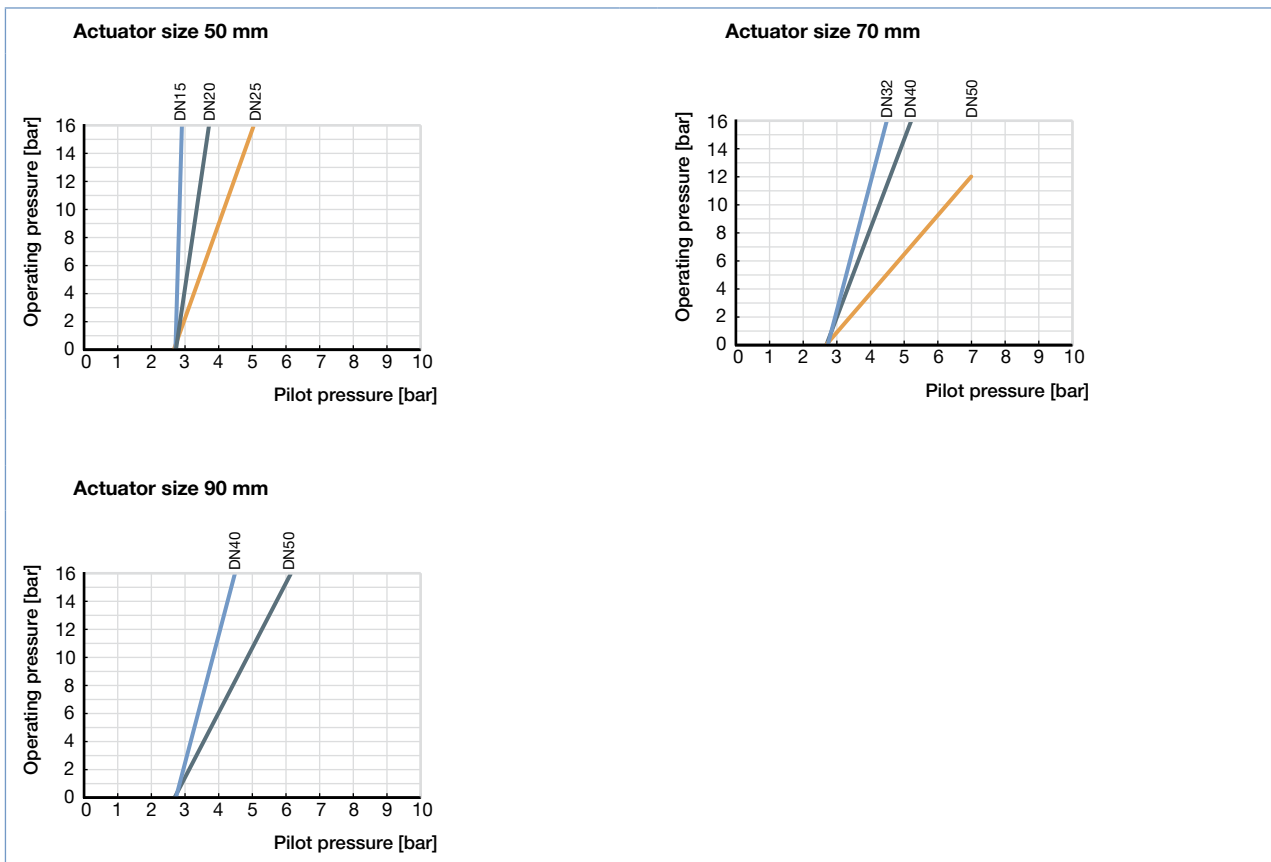





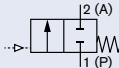







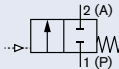



Pressure valves [bar]: Overpressure to the atmospheric pressure

Pressure charts with control function A and flow direction above the seat

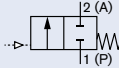

**Ordering chart angle seat valve Type 2060, flow direction above the seat** (for gases and liquids)

**Weld end body, flow direction above the seat, others on request**

Control function	Orifice		Port connection tube Ø x wall thickness [mm]	Actuator size [mm]	Pilot pressure [bar]	Operating pressure up to +185 °C [bar]	Article no.
	[mm]	[inch]					
<b>Acc. EN ISO 1127/ISO 4200/DIN 11866 series B</b>							
A Pneumatically operated on / off valve, normally closed by spring force, flow direction above seat 	15	½"	21.3 × 1.6	50 (D)	see pressure chart	16	287541 
	20	¾"	26.9 × 1.6	50 (D)		16	287542 
	25	1"	33.7 × 2.0	50 (D)		16	287543 
	32	1¼"	42.4 × 2.0	70 (M)		16	287544 
	40	1½"	48.3 × 2.0	70 (M)		16	287545 
	50	2"	60.3 × 2.0	70 (M)		12	287546 
				90 (N)		16	287547 
<b>Acc. DIN 11850 series 2/DIN 11866 series A/DIN EN 10357 series A</b>							
A Pneumatically operated on / off valve, normally closed by spring force, flow direction above seat 	15	½"	19.0 × 1.5	50 (D)	see pressure chart	16	287534 
	20	¾"	23.0 × 1.5	50 (D)		16	287535 
	25	1"	29.0 × 1.5	50 (D)		16	287536 
	32	1¼"	35.0 × 1.5	70 (M)		16	287537 
	40	1½"	41.0 × 1.5	70 (M)		16	287538 
	50	2"	53.0 × 1.5	70 (M)		12	287539 
				90 (N)		16	287540 
<b>Acc. ASME BPE/DIN 11866 series C</b>							
A Pneumatically operated on / off valve, normally closed by spring force, flow direction above seat 	15	½"	12.7 × 1.65	50 (D)	see pressure chart	16	287528 
	20	¾"	19.05 × 1.65	50 (D)		16	287529 
	25	1"	25.4 × 1.65	50 (D)		16	287530 
	40	1½"	38.1 × 1.65	70 (M)		16	287531 
	50	2"	50.8 × 1.65	70 (M)		12	287532 
				90 (N)		16	287533 

## Materials angle seat valve Type 2060

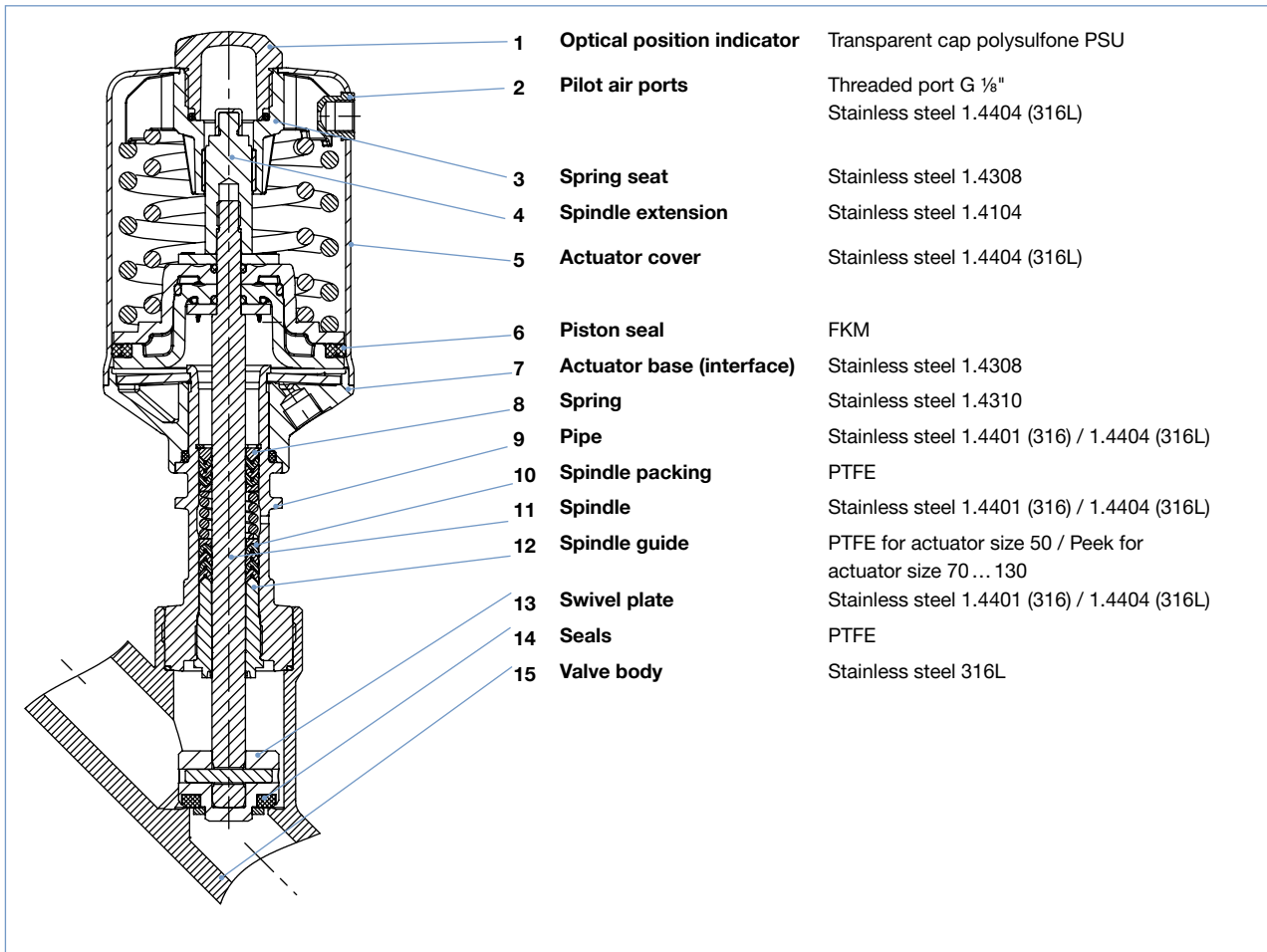

Dimensions angle seat valve Type 2060 [mm]

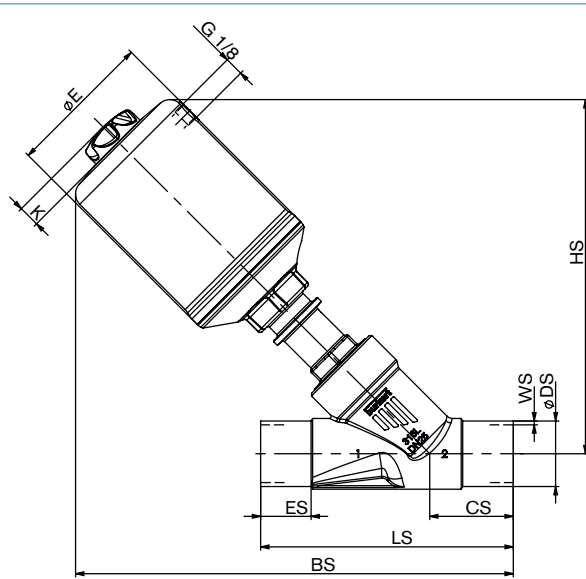

Acc. EN ISO 1127/ISO 4200/DIN 11866 series B, acc. ASME BPE/DIN 11866 series C, acc. DIN 11850 series 2/DIN 11866 series A/DIN EN 10357 series A

All bodies					acc. EN ISO 1127/ISO 4200/DIN 11866 series B						acc. ASME BPE/DIN 11866 series C					
DN [mm]	Actuator size [mm]	ØE [mm]	K [mm]	HS [mm]	BS [mm]	CS [mm]	LS [mm]	ØDS [mm]	ES [mm]	WS [mm]	BS [mm]	CS [mm]	LS [mm]	ØDS [mm]	ES [mm]	WS [mm]
15	50 (D)	55	26.5	150	184	34	100	21.3	19	1.6	293	45	135	19	15	1.65
	70 (M)	75	26.5	171	209						220					
20	50 (D)	55	26.5	155	194	39	115	26.9	20	1.6	197	52	145	19.05	25	1.65
	70 (M)	75	26.5	178	217						234					
25	50 (D)	55	26.5	161	204	43	130	33.7	26	2	212	51	152	25.4	30	1.65
	70 (M)	75	26.5	183	226						234					
32	70 (M)	75	26.5	191	236	45	145	42.4	26	2	n/a	n/a	n/a	n/a	n/a	n/a
	90 (N)	96	29	236	281						n/a	n/a	n/a	n/a	n/a	n/a
40	70 (M)	75	26.5	197	246	49	160	48.3	26	2	257	60	182	38.1	30	1.65
	90 (N)	96	29	242	291						302					
50	70 (M)	75	26.5	214	264	50	175	60.3	26	2.6	278	64	210	50.8	30	1.65
	90 (N)	96	29	257	307						321					
	130 (P)	137	29	301	352						352					
65	90 (N)	96	29	269	319	50	210	76.1	26	2.3	307	56	230	63.5	26	1.65
	130 (P)	137	29	314	364						370					

All bodies					acc. DIN 11850 series 2/DIN 11866 series A/DIN EN 10357 series A						
DN [mm]	Actuator size [mm]	ØE [mm]	K [mm]	HS [mm]	BS [mm]	CS [mm]	LS [mm]	ØDS [mm]	ES [mm]	WS [mm]	
15	50 (D)	55	26.5	150	184	34	100	19	20	1.5	
	70 (M)	75	26.5	171	209						
20	50 (D)	55	26.5	155	194	39	115	23	20	1.5	
	70 (M)	75	26.5	178	217						
25	50 (D)	55	26.5	161	204	43	130	29	26	1.5	
	70 (M)	75	26.5	183	226						
32	70 (M)	75	26.5	191	236	45	145	35	26	1.5	
	90 (N)	96	29	236	281						
40	70 (M)	75	26.5	197	246	49	160	41	26	1.5	
	90 (N)	96	29	242	291						
50	70 (M)	75	26.5	214	264	50	175	53	26	1.5	
	90 (N)	96	29	257	307						
	130 (P)	137	29	301	352						
65	90 (N)	96	29	269	319	50	210	70	26	2	
	130 (P)	137	29	314	364						



## Ordering information for valve system On/Off Type 8801-YV

A valve system On/Off Type 8801-YV consists of a angle seat valve Type 2060 and feedback Type 8697 (see separate datasheets). For the configuration of further valve systems Type 2060 and a feedback Type 8697 (see separate datasheets) please use the "Request for quotation".

### Angle seat valve Type 2060 Welded



### Type 8697 Feedback



### Valve System On/Off ELEMENT



Type 8801-YV  
2060 + 8697

### Electrical position feedback

More  
info.



### Type 8697

Actuator size 40 ... 225

The pneumatic control unit Type 8697 is designed for integrated mounting on CLASSIC series 20XX process valves suiting the requirements of hygienic process environment Mechanical or inductive limit switches register the position of the valve.

### Features

- Compact design
- LED position indicator
- Mechanical or inductive limit switches for end position registering
- Easy to clean chemically resistant housing featuring IP65 / IP67, 4X Rating
- Optional intrinsically safe version acc. to ATEX

### Benefits

- Easy and quick installation
- High level of signal reliability thanks to self adjusting limit switches
- Signal safety through the automatic adjustment of the limit switches
- Minimised space requirement in the plant piping for more flexibility in plant design

### Dimensions for valve system On/Off with stainless steel actuator Type 8801-YV [mm]

Dimensions valve system On/Off ELEMENT Type 8801-YE-K (with pneumatic control unit Type 8690)

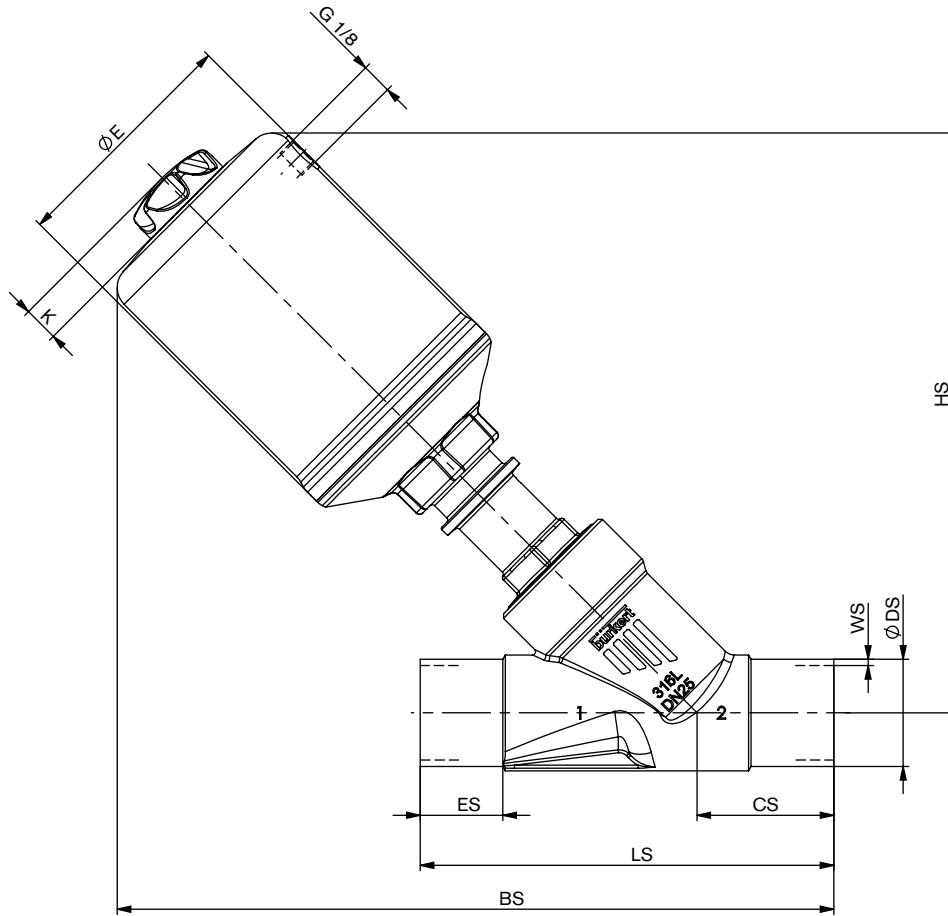

Orifice [mm]	Actuator size [mm]	BM	HM
15	D	262.5	229.1
	M	277.4	244
20	D	272.4	234.1
	M	290	251.6
25	D	282.8	240.4
	M	298.4	256.1
32	M	308.9	264.6
	N	355.9	307.5
40	M	318.4	270.1
	N	342.7	298.4
50	M	337.3	287.9
	N	368.2	318.9
	P	399.6	350.3
65	N	385.9	331.6
	P	412.4	363

Further dimensions see p. 8

## Ordering chart for accessories

### Accessories has to be ordered separately

Accessory	for actuator size	Article no.
Stainless steel Silencer Set (VA-Silencer incl. PTFE sealing ring)	universal	696931
Max. stroke limitation	D (Ø50), M (Ø70)	699550
	N (Ø90), P (Ø130)	699994
Min./Max. stroke limitation	D (Ø50), M (Ø70)	699986
	N (Ø90), P (Ø130)	699998
Proximity switch (single)	D (Ø50), M (Ø70)	699989
	N (Ø90), P (Ø130)	699991
Proximity switch (double)	D (Ø50), M (Ø70)	699990
	N (Ø90), P (Ø130)	699992
Adaptionsset 8697*	D (Ø50), M (Ø70)	699551
	N (Ø90), P (Ø130)	580000
8697*	universal	depending on version

For further accessories see accessories datasheet Type 2XXX for the full options programme.

More  
info.

## Valve system On/Off ELEMENT Type 8801-YE – request for quotation

▶ Please fill out and send to your nearest Bürkert facility with your inquiry or order

Company	Contact person
Customer no.	Department
Address	Tel./Fax
Postcode/town	E-Mail

= mandatory fields to fill out

Quantity

Required delivery date

### Operating data

Pipe line	DN	<input type="text"/>	PN	<input type="text"/>
Pipe material	<input type="text"/>			
<input checked="" type="checkbox"/> Process medium	<input type="text"/>			
<input checked="" type="checkbox"/> Type of media	<input type="checkbox"/> Liquid	<input type="checkbox"/> Steam	<input type="checkbox"/> Gas	

### Valve features

Seal material	<input type="checkbox"/> PTFE	<input type="checkbox"/> NBR	<input type="checkbox"/> Other	<input type="text"/>
Nominal pressure	PN	<input type="text"/>		
Orifice	DN	<input type="text"/>		
Type of connection	<input type="checkbox"/> Threaded	<input type="checkbox"/> Welded	<input type="checkbox"/> Clamp	
Standard connection	<input type="checkbox"/> ISO	<input type="checkbox"/> DIN	<input type="checkbox"/> Other <input type="text"/>	
Control function	<input type="checkbox"/> NC <sup>1)</sup>	<input type="checkbox"/> NO <sup>1)</sup>	<input type="checkbox"/> Double-acting	
Pilot pressure	<input type="text"/>	min.	<input type="text"/>	max.
Atex II 2GD Mechanical	<input type="checkbox"/>			
Please specify item no. (if known):	<input type="text"/>			

<sup>1)</sup> NC: normally closed by spring action; NO: normally open by spring action

### Note

You can fill out the fields directly in the PDF file before printing out the form.

Continued on next page →

Valve system On/Off ELEMENT Type 8801-YE – request for quotation, *continued*

**Automation unit features**

Click on the orange box "More info"... you will come to our website for the resp. product where you can download the data sheet.

**Electrical Feedback**

**Type 8697**  
For actuator size 50... 130





LED-position indicator  
Micro- or proximity switches for end position feedback  
Gehäuse nach IP65/67, 4X Rating  
Optional intrinsically safe version acc. to ATEX / IECEx

<b>Position feedback switches</b>	<b>Electrical connection</b>
<input type="checkbox"/> Micro-switch 24 V DC	<input type="checkbox"/> Cable gland
<input type="checkbox"/> Micro-switch 50... 225 V DC/AC	
<input type="checkbox"/> Inductive switch 3-wire PNP	<input type="checkbox"/> M12 plug
<input type="checkbox"/> Inductive switch 2-wire NAMUR	(only with inductive switch
<input type="checkbox"/> Inductive switch 2-wire 24 V DC	3-wire PNP)

<b>No. of Position feedback switches</b>	<b>Approvals</b>
<input type="checkbox"/> 2x	<input type="checkbox"/> ATEX cat. 3GD, IECEx
	<input type="checkbox"/> ATEX cat. 2DG, IECEx
	<input type="checkbox"/> without

**Certifications**

- Attestation of compliance with the order EN-ISO 10204 2.1 (Article no. 440788)
- Test report EN-ISO 10204 2.2 (Article no. 803722)
- Certification of Conformity for Raw Material EN-ISO 10204 3.1 (Included in delivery)
- FDA compliance
- Compliance EC-Regulation 1935/2004

**Comment /sketch**

To find your nearest Bürkert facility, click on the orange box → [www.burkert.com](http://www.burkert.com)

In case of special application conditions, please consult for advice.

Subject to alteration.  
© Christian Bürkert GmbH & Co. KG

1804/3\_EU-en\_00895312

DTS 1000290884 EN Version: D Status: RL (released | freigegeben | validé) printed: 11.02.2020